

IRGI4061DPbF

INSULATED GATE BIPOLAR TRANSISTOR WITH ULTRAFAST SOFT RECOVERY DIODE

Features

- Low $V_{CE(on)}$ Trench IGBT Technology
- Low Switching Losses
- 5 μ s SCSOA
- Square RBSOA
- 100% of The Parts Tested for I_{LM}
- Positive $V_{CE(on)}$ Temperature Coefficient.
- Ultra Fast Soft Recovery Co-pak Diode
- Tighter Distribution of Parameters
- Lead-Free Package

Benefits

- High Efficiency in a Wide Range of Applications
- Suitable for a Wide Range of Switching Frequencies due to Low $V_{CE(ON)}$ and Low Switching Losses
- Rugged Transient Performance for Increased Reliability
- Excellent Current Sharing in Parallel Operation
- Low EMI

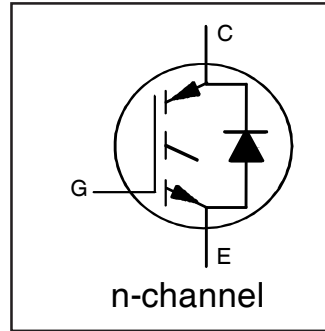

$V_{CES} = 600V$
$I_C = 11A, T_C = 100^\circ C$
$t_{sc} > 5\mu s, T_{jmax} = 150^\circ C$
$V_{CE(on) typ.} = 1.35V$

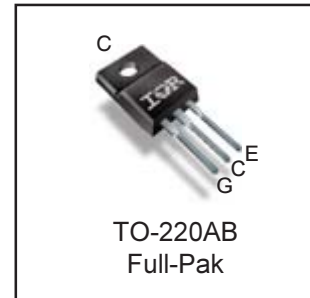

G	C	E
Gate	Collector	Emitter

Absolute Maximum Ratings

	Parameter	Max.	Units
V_{CES}	Collector-to-Emitter Breakdown Voltage	600	V
$I_C @ T_C = 25^\circ C$	Continuous Collector Current	20	A
$I_C @ T_C = 100^\circ C$	Continuous Collector Current	11	
I_{CM}	Pulsed Collector Current	40	
I_{LM}	Clamped Inductive Load Current ①	40	
$I_F @ T_C = 25^\circ C$	Diode Continuous Forward Current	20	
$I_F @ T_C = 100^\circ C$	Diode Continuous Forward Current	11	
I_{FM}	Diode Maximum Forward Current ②	40	
V_{GE}	Continuous Gate-to-Emitter Voltage	± 20	V
	Transient Gate-to-Emitter Voltage	± 30	
$P_D @ T_C = 25^\circ C$	Maximum Power Dissipation	43	W
$P_D @ T_C = 100^\circ C$	Maximum Power Dissipation	17	
T_J	Operating Junction and Storage Temperature Range	-55 to + 150	$^\circ C$
T_{STG}			
	Soldering Temperature, for 10 seconds	300 (0.063 in. (1.6mm) from case)	
	Mounting Torque, 6-32 or M3 Screw	10 lbf·in (1.1 N·m)	

Thermal Resistance

	Parameter	Min.	Typ.	Max.	Units
$R_{\theta JC}$	Junction-to-Case - IGBT ③	—	—	2.90	$^\circ C/W$
$R_{\theta JC}$	Junction-to-Case - Diode ③	—	—	4.60	
$R_{\theta CS}$	Case-to-Sink, flat, greased surface	—	0.5	—	
$R_{\theta JA}$	Junction-to-Ambient, typical socket mount ③	—	—	65	
Wt	Weight	—	2.0	—	g

Electrical Characteristics @ $T_J = 25^\circ\text{C}$ (unless otherwise specified)

	Parameter	Min.	Typ.	Max.	Units	Conditions
$V_{(BR)CES}$	Collector-to-Emitter Breakdown Voltage	600	—	—	V	$V_{GE} = 0V, I_C = 100 \mu\text{A}$ ④
$\Delta V_{(BR)CES}/\Delta T_J$	Temperature Coeff. of Breakdown Voltage	—	0.75	—	V/°C	$V_{GE} = 0V, I_C = 250 \mu\text{A}$ (-55 -150 °C) ④
$V_{CE(on)}$	Collector-to-Emitter Saturation Voltage	—	1.35	1.59	V	$I_C = 11A, V_{GE} = 15V, T_J = 25^\circ\text{C}$
		—	1.53	—		$I_C = 11A, V_{GE} = 15V, T_J = 125^\circ\text{C}$
		—	1.58	—		$I_C = 11A, V_{GE} = 15V, T_J = 150^\circ\text{C}$
$V_{GE(th)}$	Gate Threshold Voltage	4.0	—	6.5	V	$V_{CE} = V_{GE}, I_C = 500 \mu\text{A}$
$\Delta V_{GE(th)}/\Delta T_J$	Threshold Voltage temp. coefficient	—	-15	—	mV/°C	$V_{CE} = V_{GE}, I_C = 1.0\text{mA}$ (25 -150 °C)
g_{fe}	Forward Transconductance	—	11	—	S	$V_{CE} = 50V, I_C = 11A, PW = 80\mu\text{s}$
I_{CES}	Collector-to-Emitter Leakage Current	—	2.0	25	μA	$V_{GE} = 0V, V_{CE} = 600V$
		—	550	—	μA	$V_{GE} = 0V, V_{CE} = 600V, T_J = 150^\circ\text{C}$
V_{FM}	Diode Forward Voltage Drop	—	1.84	2.05	V	$I_F = 11A$
		—	1.33	—	V	$I_F = 11A, T_J = 150^\circ\text{C}$
I_{GES}	Gate-to-Emitter Leakage Current	—	—	± 100	nA	$V_{GE} = \pm 20 V$

Switching Characteristics @ $T_J = 25^\circ\text{C}$ (unless otherwise specified)

	Parameter	Min.	Typ.	Max.	Units	Conditions
Q_g	Total Gate Charge (turn-on)	—	35	53	nC	$I_C = 11A$
Q_{ge}	Gate-to-Emitter Charge (turn-on)	—	8.0	12		$V_{CC} = 400V$
Q_{gc}	Gate-to-Collector Charge (turn-on)	—	13	23		$V_{GE} = 15V$
E_{on}	Turn-On Switching Loss	—	52	95	μJ	$I_C = 11A, V_{CC} = 400V, V_{GE} = 15V$
E_{off}	Turn-Off Switching Loss	—	231	340		$R_G = 22\Omega, L = 1\text{mH}, L_S = 150\text{nH}, T_J = 25^\circ\text{C}$
E_{total}	Total Switching Loss	—	283	435		Energy losses include tail and diode reverse recovery
$t_{d(on)}$	Turn-On delay time	—	37	46	ns	$I_C = 11A, V_{CC} = 400V$
t_r	Rise time	—	18	26		$R_G = 22\Omega, L = 1\text{mH}, L_S = 150\text{nH}$
$t_{d(off)}$	Turn-Off delay time	—	111	129		$T_J = 25^\circ\text{C}$
t_f	Fall time	—	30	41		
E_{on}	Turn-On Switching Loss	—	143	—		μJ
E_{off}	Turn-Off Switching Loss	—	316	—	μJ	$R_G = 22\Omega, L = 1\text{mH}, L_S = 150\text{nH}, T_J = 150^\circ\text{C}$
E_{total}	Total Switching Loss	—	459	—	μJ	Energy losses include tail and diode reverse recovery
$t_{d(on)}$	Turn-On delay time	—	35	—	ns	$I_C = 11A, V_{CC} = 400V$
t_r	Rise time	—	19	—		$R_G = 22\Omega, L = 1\text{mH}, L_S = 150\text{nH}$
$t_{d(off)}$	Turn-Off delay time	—	134	—		$T_J = 150^\circ\text{C}$
t_f	Fall time	—	45	—		
C_{ies}	Input Capacitance	—	1050	—	pF	$V_{GE} = 0V$
C_{oes}	Output Capacitance	—	89	—		$V_{CC} = 30V$
C_{res}	Reverse Transfer Capacitance	—	30	—		$f = 1\text{Mhz}$
RBSOA	Reverse Bias Safe Operating Area	FULL SQUARE				$T_J = 150^\circ\text{C}, I_C = 40A$ $V_{CC} = 480V, V_p = 600V$ $R_G = 22\Omega, V_{GE} = +15V \text{ to } 0V$
SCSOA	Short Circuit Safe Operating Area	5	—	—	μs	$V_{CC} = 400V, V_p = 600V$ $R_G = 22\Omega, V_{GE} = +15V \text{ to } 0V$
E_{rec}	Reverse recovery energy of the diode	—	211	—	μJ	$T_J = 150^\circ\text{C}$
t_{rr}	Diode Reverse recovery time	—	60	—	ns	$V_{CC} = 400V, I_F = 11A$
I_{rr}	Peak Reverse Recovery Current	—	18	—	A	$V_{GE} = 15V, R_G = 22\Omega, L = 1\text{mH}, L_S = 150\text{nH}$

Notes:

- ① $V_{CC} = 80\% (V_{CES}), V_{GE} = 15V, L = 28 \mu\text{H}, R_G = 22 \Omega$.
- ② Pulse width limited by max. junction temperature.
- ③ R_θ is measured at T_J approximately 90°C
- ④ Refer to AN-1086 for guidelines for measuring $V_{(BR)CES}$ safely

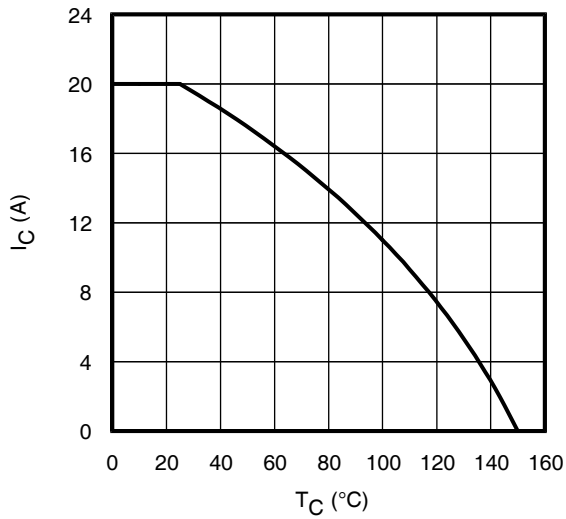

Fig. 1 - Maximum DC Collector Current vs. Case Temperature

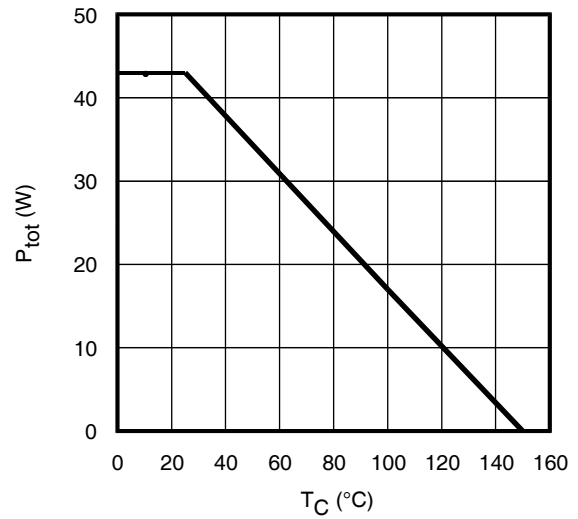

Fig. 2 - Power Dissipation vs. Case Temperature

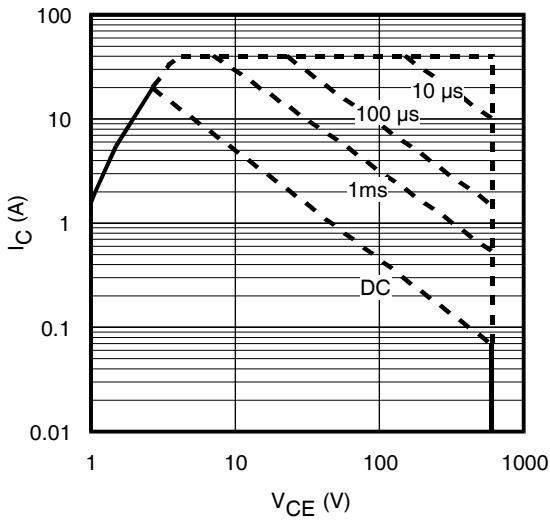

Fig. 3 - Forward SOA,
 $T_C = 25^\circ\text{C}$; $T_J \leq 150^\circ\text{C}$

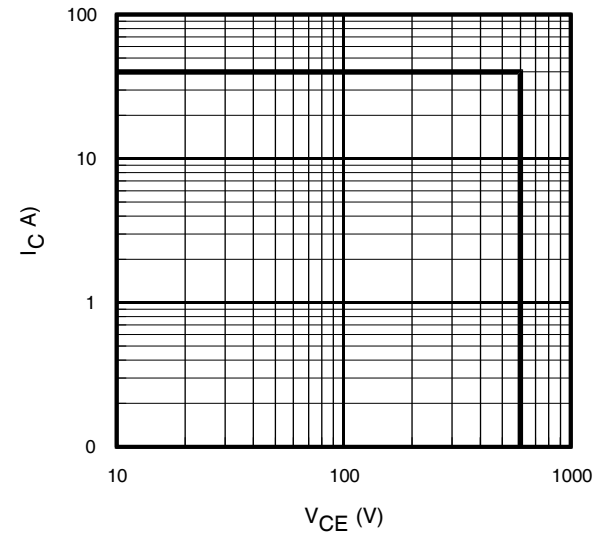

Fig. 4 - Reverse Bias SOA
 $T_J = 150^\circ\text{C}$; $V_{CE} = 15\text{V}$

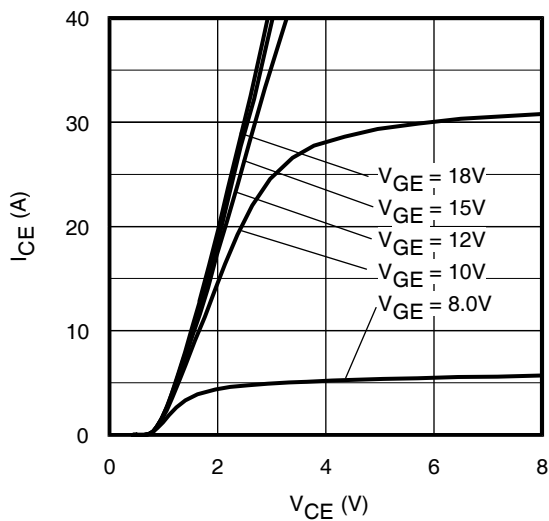

Fig. 5 - Typ. IGBT Output Characteristics
 $T_J = -40^\circ\text{C}$; $t_p < 60\mu\text{s}$

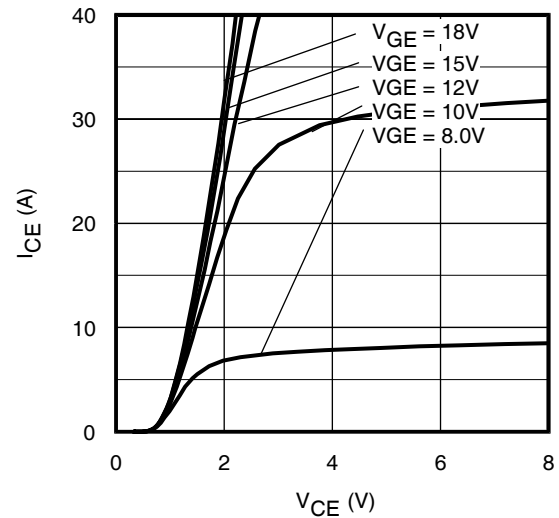

Fig. 6 - Typ. IGBT Output Characteristics
 $T_J = 25^\circ\text{C}$; $t_p < 60\mu\text{s}$

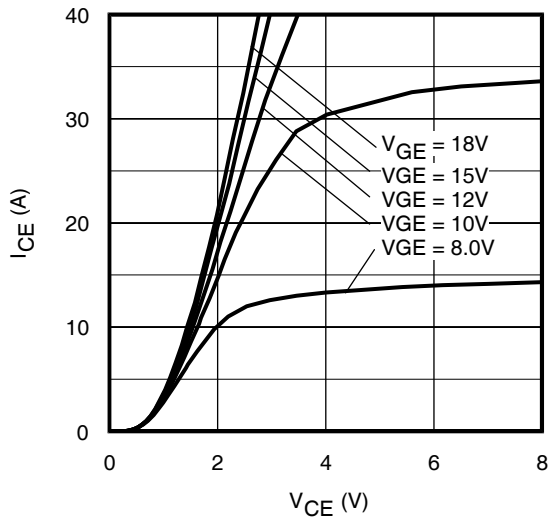

Fig. 7 - Typ. IGBT Output Characteristics
 $T_J = 150^\circ\text{C}$; $t_p < 60\mu\text{s}$

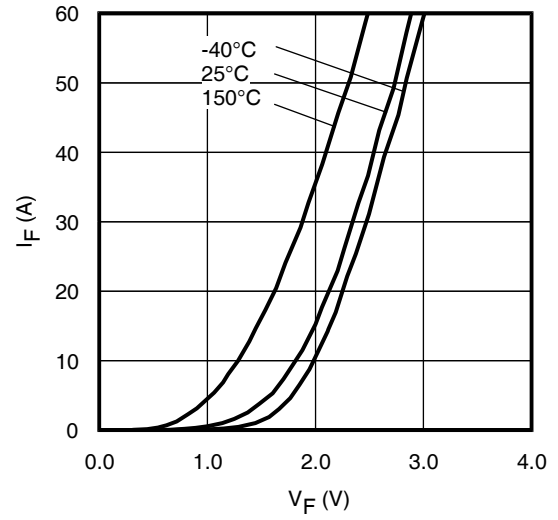

Fig. 8 - Typ. Diode Forward Characteristics
 $t_p < 60\mu\text{s}$

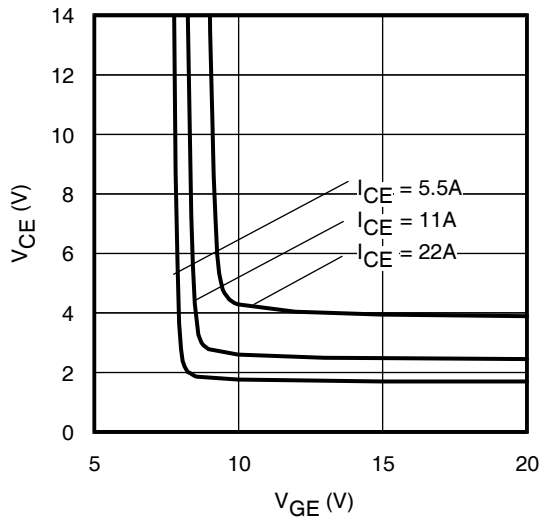

Fig. 9 - Typical V_{CE} vs. V_{GE}
 $T_J = -40^\circ\text{C}$

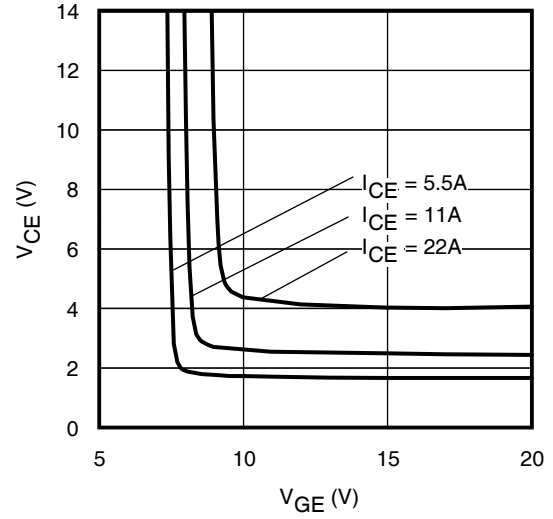

Fig. 10 - Typical V_{CE} vs. V_{GE}
 $T_J = 25^\circ\text{C}$

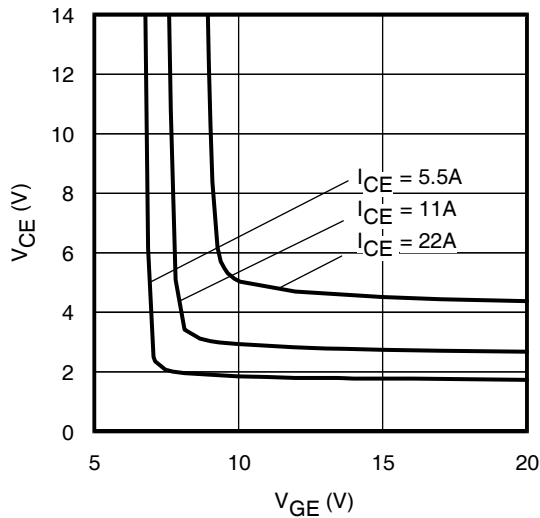

Fig. 11 - Typical V_{CE} vs. V_{GE}
 $T_J = 150^\circ\text{C}$

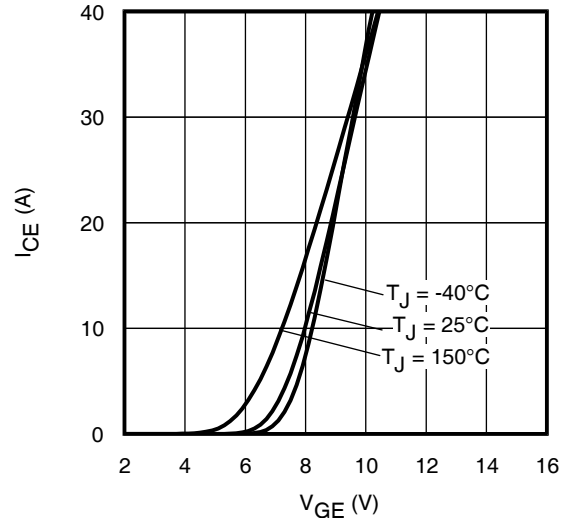

Fig. 12 - Typ. Transfer Characteristics
 $V_{CE} = 50\text{V}$; $t_p < 60\mu\text{s}$

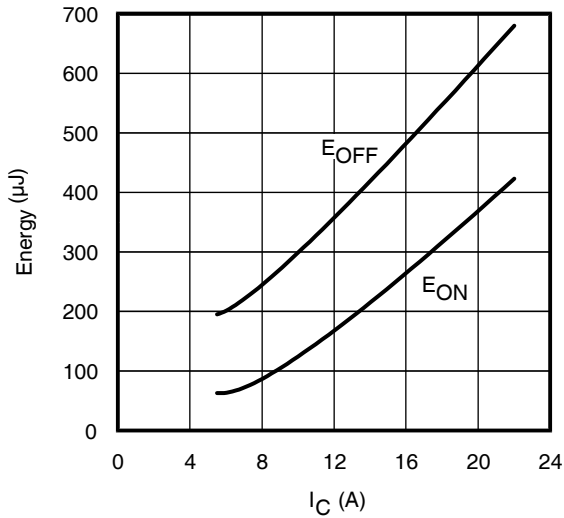

Fig. 13 - Typ. Energy Loss vs. I_C
 $T_J = 150^\circ\text{C}$; $L = 1\text{mH}$; $V_{CE} = 400\text{V}$, $R_G = 22\Omega$; $V_{GE} = 15\text{V}$.

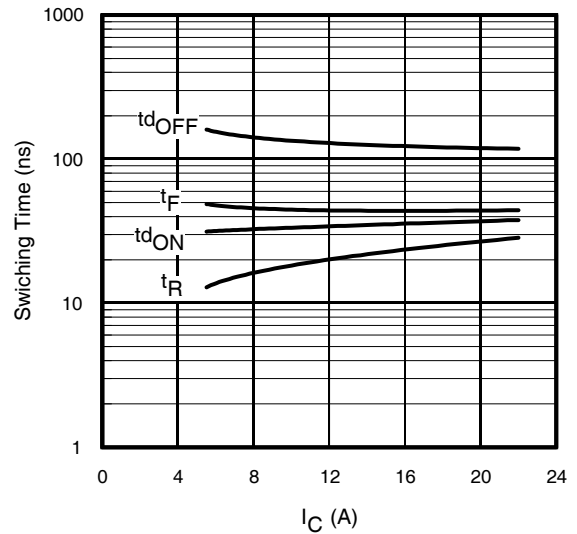

Fig. 14 - Typ. Switching Time vs. I_C
 $T_J = 150^\circ\text{C}$; $L = 1\text{mH}$; $V_{CE} = 400\text{V}$
 $R_G = 22\Omega$; $V_{GE} = 15\text{V}$

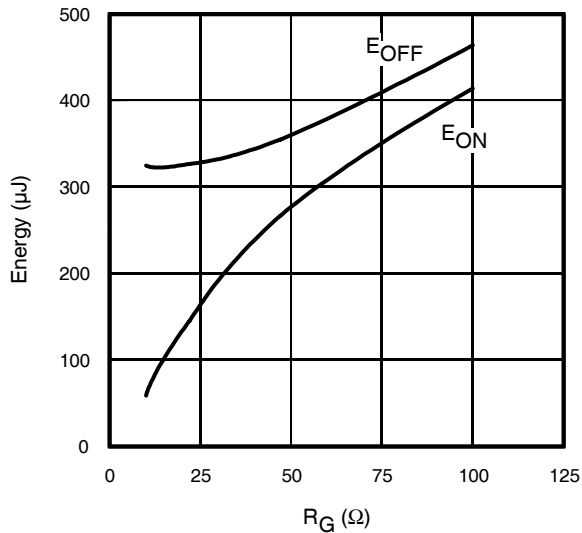

Fig. 15 - Typ. Energy Loss vs. R_G
 $T_J = 150^\circ\text{C}$; $L = 1\text{mH}$; $V_{CE} = 400\text{V}$, $I_{CE} = 11\text{A}$; $V_{GE} = 15\text{V}$

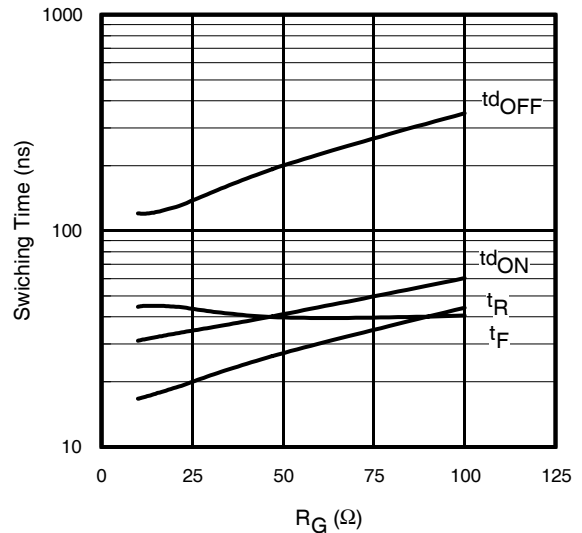

Fig. 16 - Typ. Switching Time vs. R_G
 $T_J = 150^\circ\text{C}$; $L = 1\text{mH}$; $V_{CE} = 400\text{V}$
 $I_{CE} = 11\text{A}$; $V_{GE} = 15\text{V}$

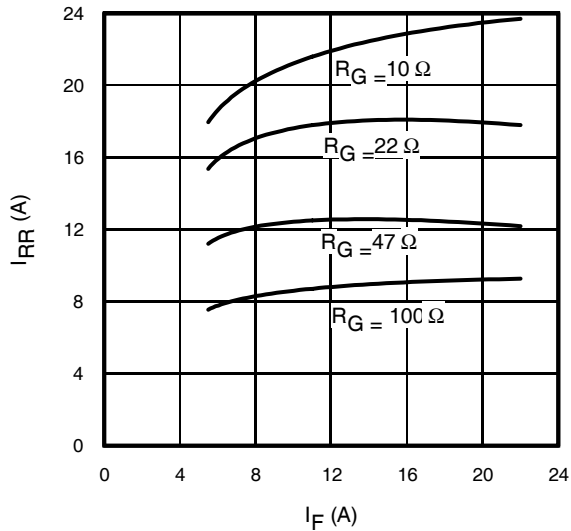

Fig. 17 - Typical Diode I_{RR} vs. I_F
 $T_J = 150^\circ\text{C}$

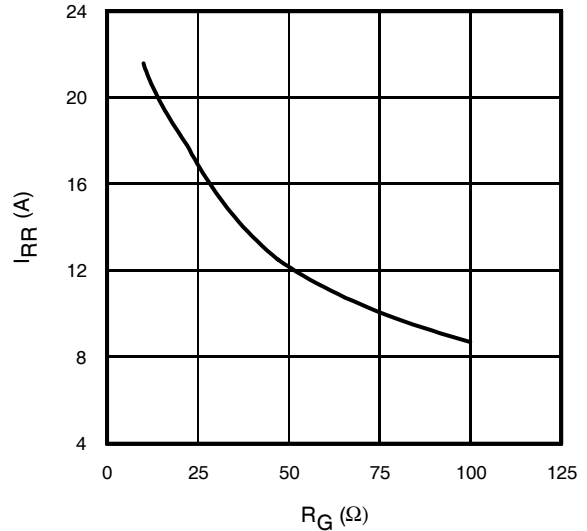

Fig. 18 - Typical Diode I_{RR} vs. R_G
 $T_J = 150^\circ\text{C}$; $I_F = 11\text{A}$

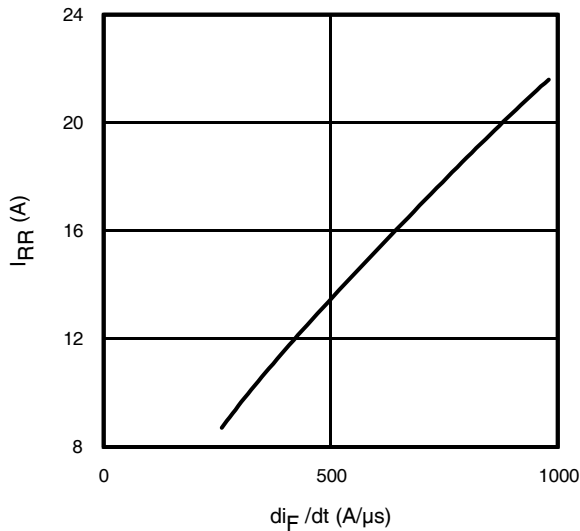

Fig. 19 - Typical Diode I_{RR} vs. di_F/dt
 $V_{CC}= 400V$; $V_{GE}= 15V$;
 $I_{CE}= 11A$; $T_J = 150^{\circ}C$

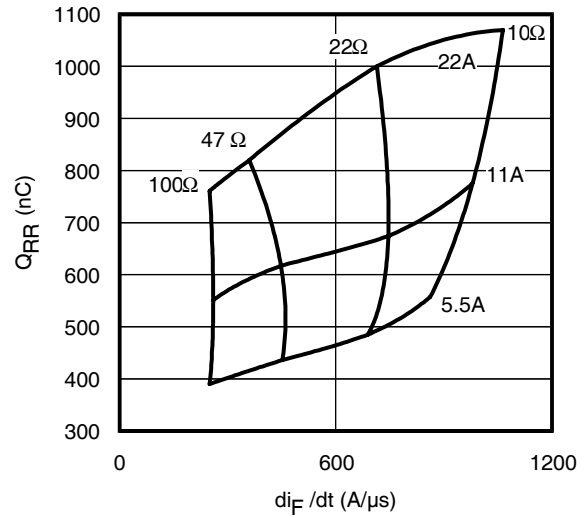

Fig. 20 - Typical Diode Q_{RR}
 $V_{CC}= 400V$; $V_{GE}= 15V$; $T_J = 150^{\circ}C$

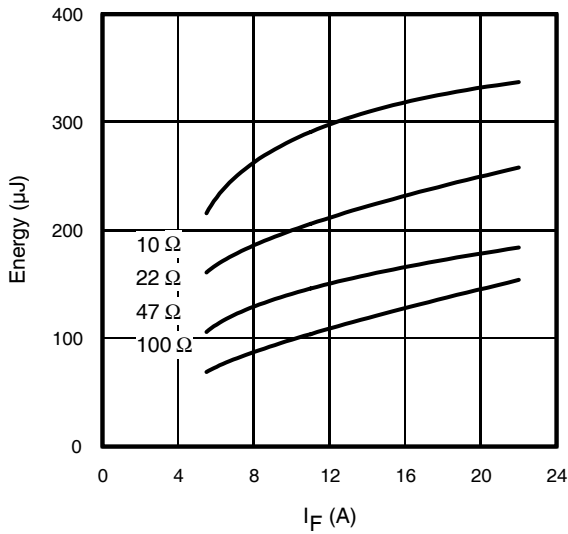

Fig. 21 - Typical Diode E_{RR} vs. I_F
 $T_J = 150^{\circ}C$

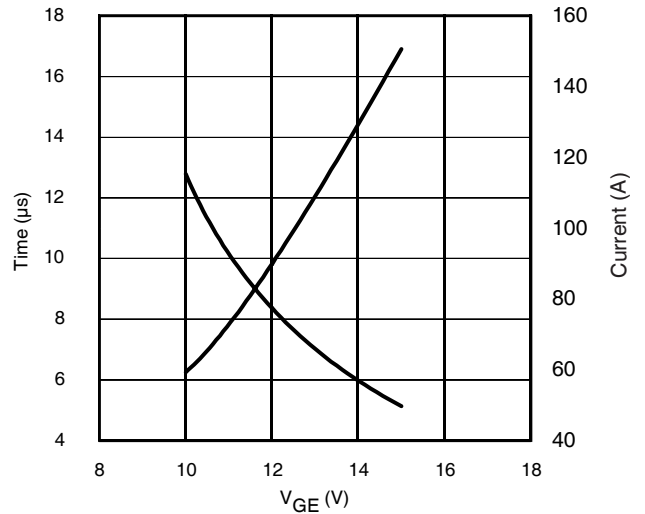

Fig. 22 - Typ. V_{GE} vs Short Circuit Time
 $V_{CC}=400V$, $T_C = 25^{\circ}C$

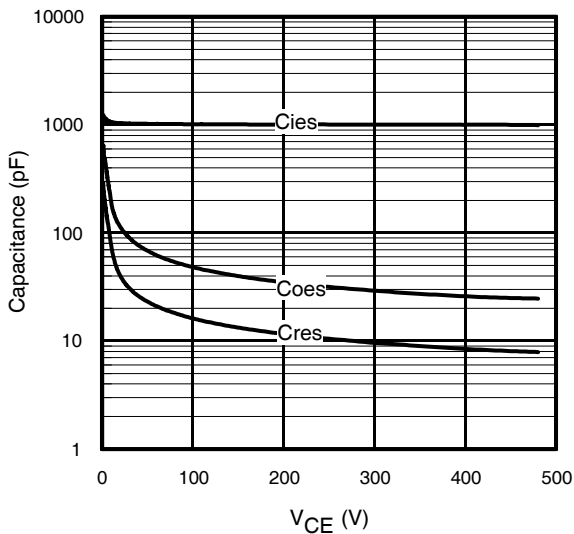

Fig. 23 - Typ. Capacitance vs. V_{CE}
 $V_{GE}= 0V$; $f = 1MHz$

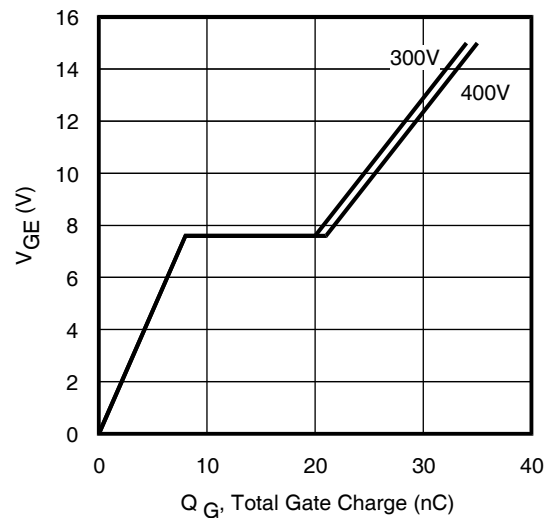

Fig. 24 - Typical Gate Charge vs. V_{GE}
 $I_{CE} = 11A$, $L=600\mu H$

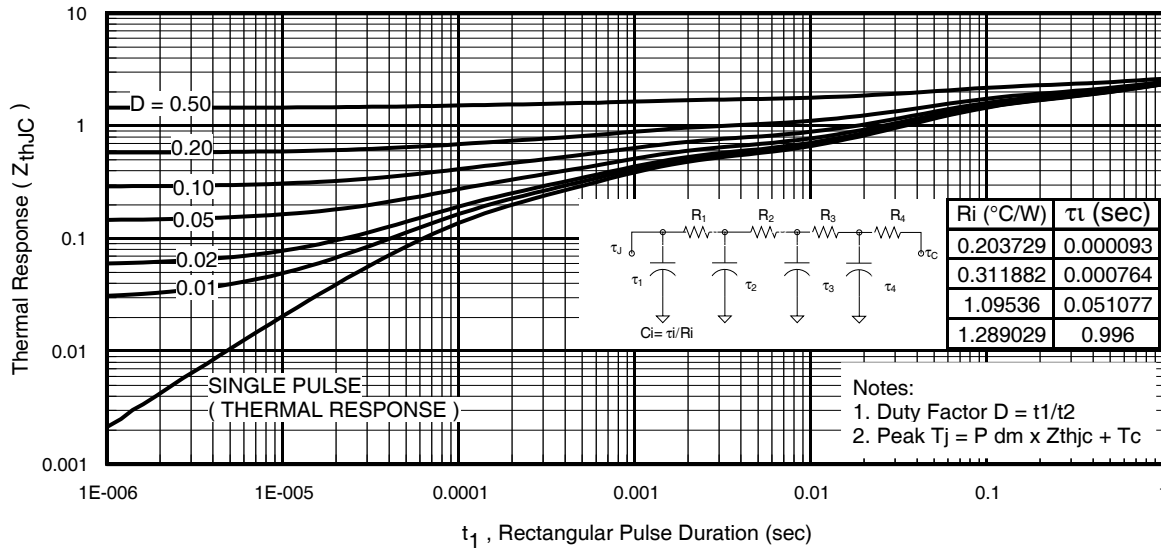

Fig 25. Maximum Transient Thermal Impedance, Junction-to-Case (IGBT)

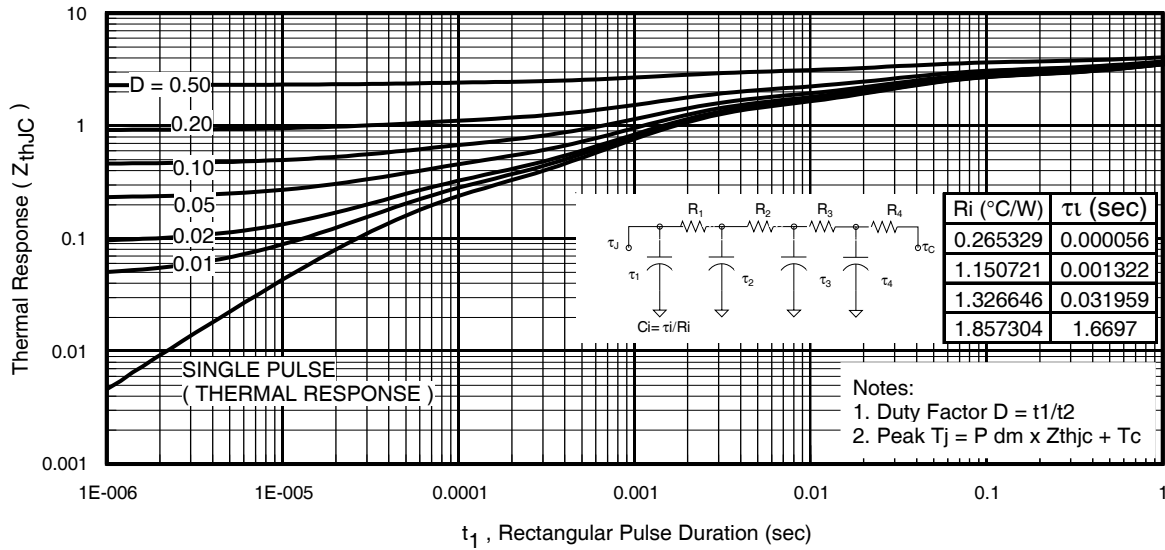

Fig. 26. Maximum Transient Thermal Impedance, Junction-to-Case (DIODE)

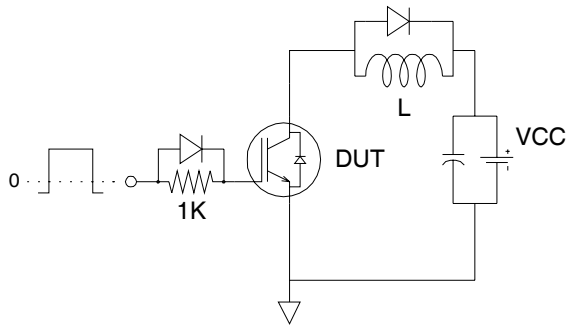

Fig.C.T.1 - Gate Charge Circuit (turn-off)

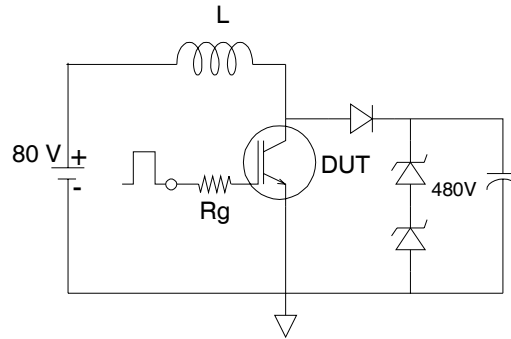

Fig.C.T.2 - RBSOA Circuit

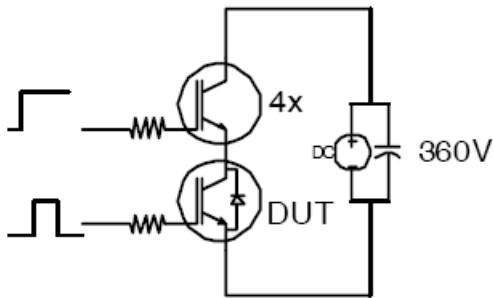

Fig.C.T.3 - S.C.SOA Circuit

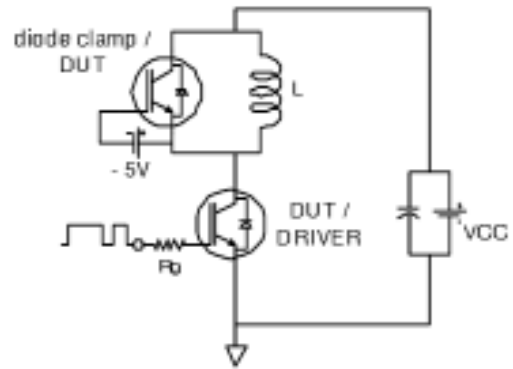

Fig.C.T.4 - Switching Loss Circuit

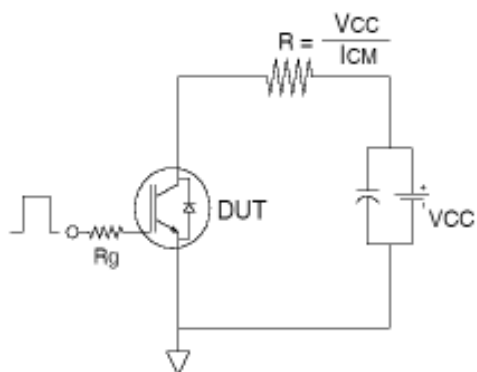

Fig.C.T.5 - Resistive Load Circuit

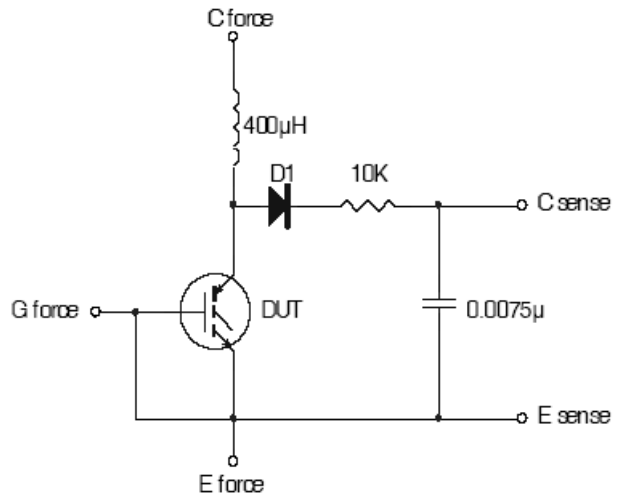

Fig.C.T.6 - Typical Filter Circuit for $V_{(BR)CES}$ Measurement

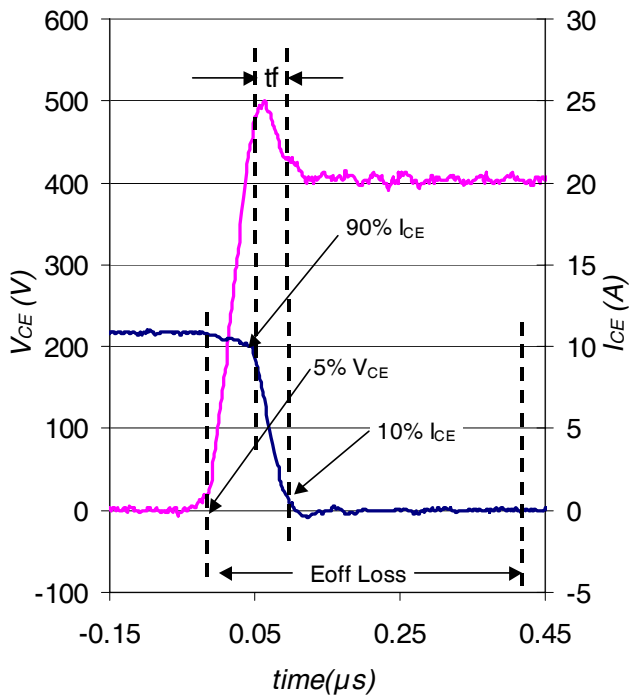

Fig. WF1 - Typ. Turn-off Loss Waveform
@ $T_J = 150^\circ C$ using Fig. CT.4

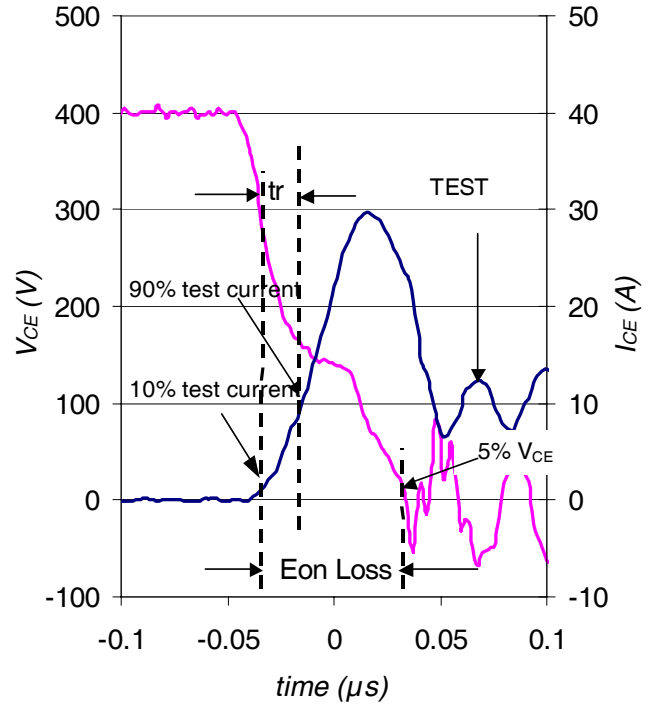
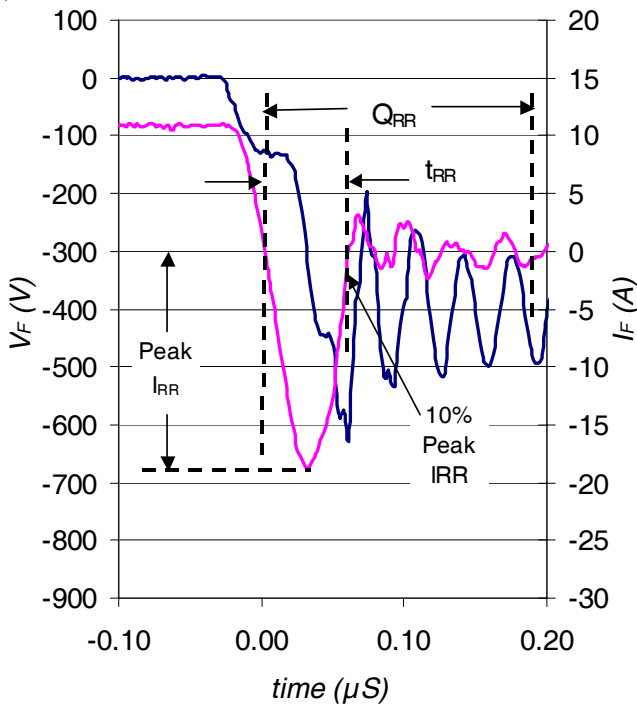
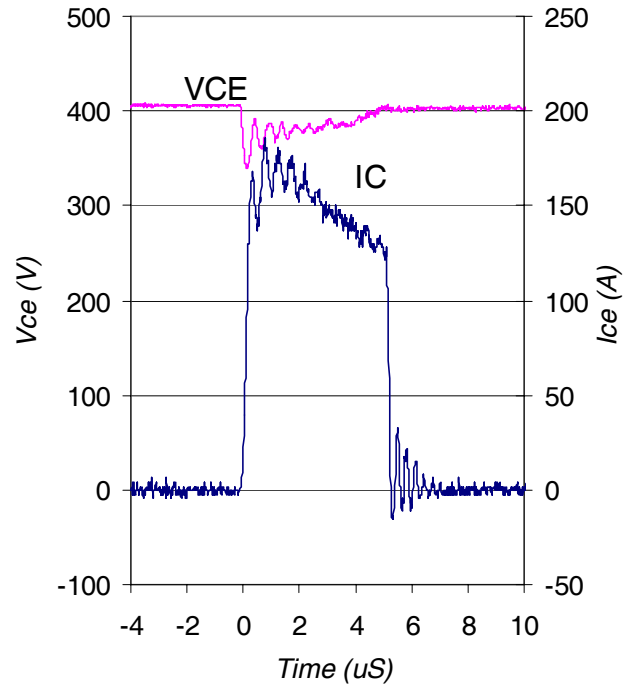

Fig. WF2 - Typ. Turn-on Loss Waveform
@ $T_J = 150^\circ C$ using Fig. CT.4



WF.3- Typ. Reverse Recovery Waveform
@ $T_J = 150^\circ C$ using CT.4



WF.4- Typ. Short Circuit Waveform
@ $T_J = 25^\circ C$ using CT.3

Note: For the most current drawings please refer to the IR website at:
<http://www.irf.com/package/>